

**VIDAR**  
INNOVACIÓN ECOLÓGICA



# CATÁLOGO

Pisos HDF - SPC  
Panel wall y cielo raso

Contáctanos  
[www.vidarperu.com](http://www.vidarperu.com)

Somos una empresa dedicada a la fabricación y distribución de productos ecológicos, de clase mundial en cuanto a soluciones de acabados y decoración, ideal para diversos ambientes ya sea, empresariales, comerciales residenciales, distribuyendo a grandes compañías en todo el país.

Asimismo, nuestros productos como pisos SPC, cielo raso PVC, policarbonato, Wall panel WPC, panel ecológico integrado y molduras de WPC, están diseñados para diversos ambientes.

Utilizamos materia prima reciclada con innovación ecológica ya que es obtenida sin emplear compuestos químicos que dañen el medio ambiente.



**VIDAR**  
INNOVACIÓN ECOLÓGICA



Los pisos laminados son atractivos, fáciles de mantener y duraderos con su diseño de múltiples capas.

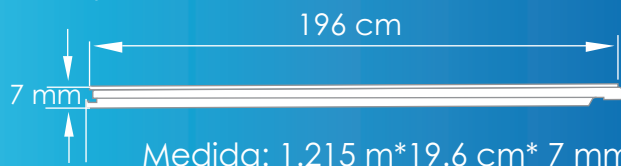

Impermeable



Medida: 1.215 m\*19.6 cm\* 7 mm. Clase: 31 AC3



10 piezas



2.38 M<sup>2</sup>



14.60 Kg



Código: 01L-7  
Color: Grey Natural.



Código: 25726L07  
Color: White Oak.



Código: 02L-7  
Color: Roble cerezo.



## Zócalo

Código: LZ01L.80

Uso: Acabado para parte inferior de paredes.

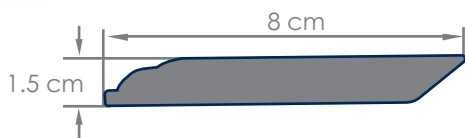

## Transición R.

Código: AS05L.45

Uso: se emplea para la terminaciones y acabdos de pisos.

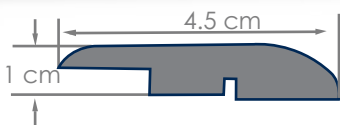
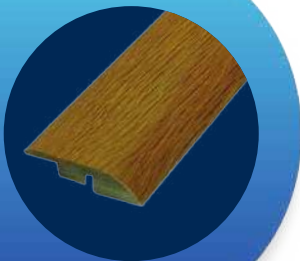

## Colores



## Dilatación T.

Código: AS04L.45

Uso: se emplea para división de ambientes.

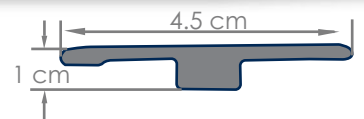
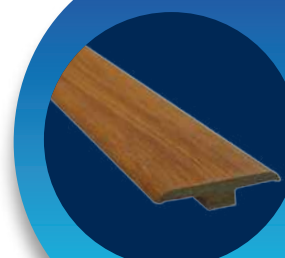

## Naríz de escalera

Código: AS06L.45

Uso: empleado para terminaciones de escalones.

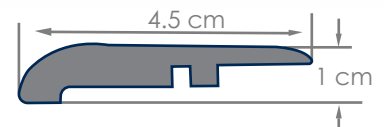

Código: AS04.0000

Manto contrapiso de amortiguación.  
Es térmica y acústica.

Medida: 16.9 x 1.10 m.

Peso: 0.98 Kg.

Uso: Para pisos laminados.

Rendimiento: 18.60 m<sup>2</sup>

## Estructura del Tablero

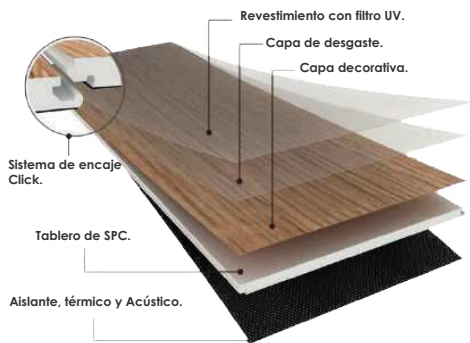

El suelo SPC es conocido por ser 100% impermeable con alta durabilidad. Los lujosos tabloncillos de vinilo son elaborados con tecnologías avanzadas para simular maravillosamente la madera y las piedras naturales.



Clase: 32 AC 4.

Medida: 1.22 m\*18.2 cm\*4.5 mm.



Código: 2003-10  
 Color: Almond.



Código: 8117  
 Color: Winter Rock.



Código: 8034  
 Color: Kona.



Código: 8065  
 Color: Ashes.



Código: 2022  
 Color: Cognac.



Código: 2078  
 Color: Summer Oal.



10 piezas



2.22 M<sup>2</sup>



16.18 kg.



5 años de garantía.



Ignífugo.



Anti-polillas



5 años de garantía.



Ignifugo.



Anti-polillas

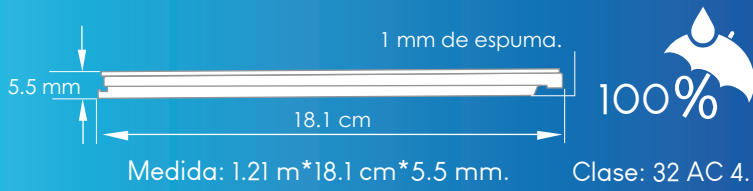

Código: 8108  
Color: Golden Oak.



Código: 1020-15  
Color: Maple.



Código: 8145  
Color: Alaska.



Código:034  
Color: Ash Grey.



Código: 0020  
Color: Cottage.



Código: 88423-3  
Color: Oak.

## Estructura del Tablero

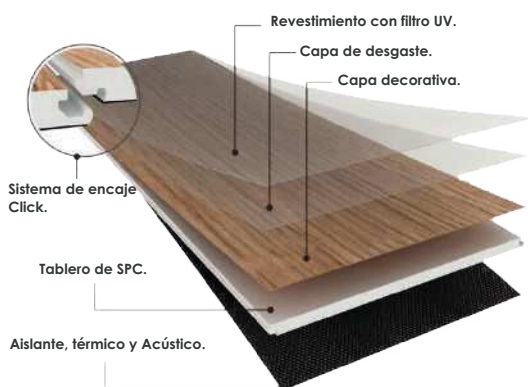

12 piezas



2.65 M<sup>2</sup>



22.52 kg.



Código: 3016-2  
Color: Arctic Gray.



Código: 8139  
Color: American.

# Estructura del Tablero

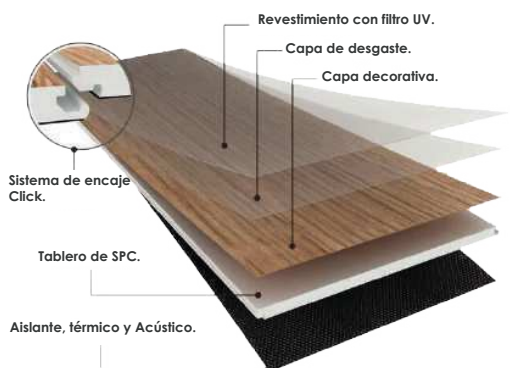

100% Clase: 32 AC 5.

7.5 mm 18.2 cm 1 mm de espuma.  
Medida: 1.22 m\*18.2 cm\*7.5 mm.

8 piezas

1.78 M<sup>2</sup>

23 kg.



Código: 8019  
Color: Toscana.



Código: 8022  
Color: Dakar.



5 años de garantía.



Ignífugo.



Anti-polillas



5 años de garantía.



Ignífugo.

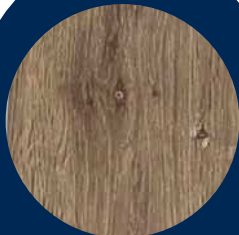

Anti-polillas

**Zócalo**

Código: LZ01.80

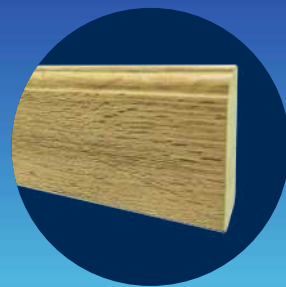
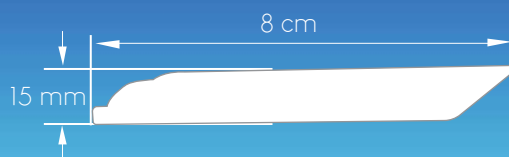
**Dilatación T.**

Código: AS04.45

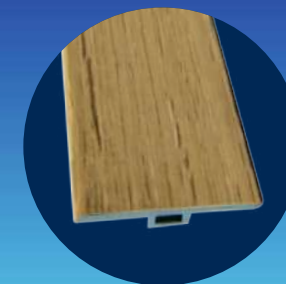
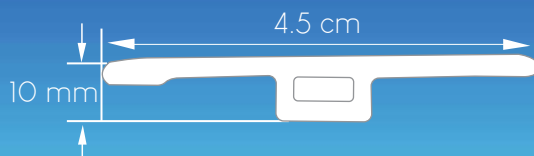
**Transición R.**

Código: AS05.45

**Naríz de escalera**

Código: AS05.45

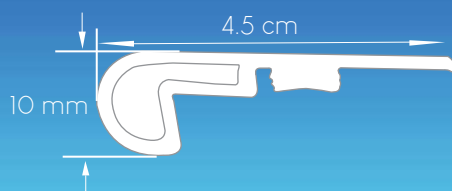



Los paneles de WPC son ideales para la decoración de paredes en áreas comerciales y residenciales.

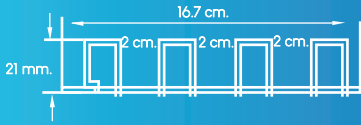

**Materia:** WPC.

**Código:** PW01.170

**Medidas:**  
2.9 m\* 16.7 cm \* 21 mm.

**Porcentaje de material:**  
60% de fibra de bambú / 40% PVC.



5 años de garantía.



Ignífugo.



Anti-piñellas



Código: 170.1601



Código: 170.1602



Código: 170.1603



Código: 170.1604



Código: 170.1605



Código: 170.1606



Código: 170.1607



Código: 170.1608



Código: 170.1609

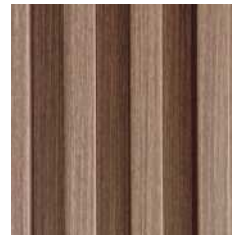

Código: 170.P-14



Código: 170.P-24



Código: 170.P-30



Código: 170.P-37



Código: 170.P-53



Código: 170.P-55



Código: 170.P-77

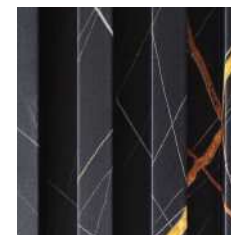

Código: 170.P-406

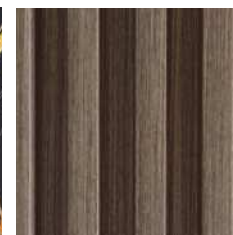

Código: 170.WPC05





Código: 170.P-04

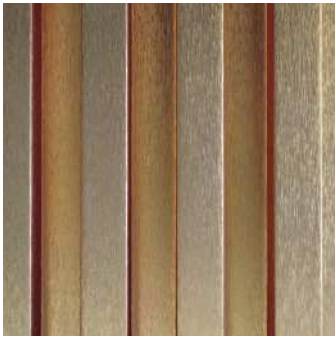

Código: 170.P-06



Código: 170.1610



Código: 170.1611

Los paneles de WPC son ideales para la decoración de paredes en áreas comerciales y residenciales.

**Materia:** WPC.

**Código:** PW01.170

**Medidas:**

2.9 m \* 16.7 cm \* 21 mm.

**Porcentaje de material:**

60% de fibra de bambú / 40% PVC.



100%

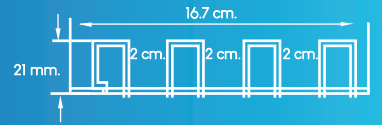

10 piezas



5 años de garantía.



Ignífugo.



Anti-polillas



Código: 195.P-106



Código:195.P-37

**Materia:** WPC.  
**Código:** PW01.195  
**Medidas:** 2.9 m\* 19.5 cm \* 28 mm.  
**Porcentaje de material:** 60% de fibra de bambú / 40% PVC.

100%

**Materia:** WPC.  
**Código:** PW01.160  
**Medidas:** 2.9 m\* 16 cm \* 15 mm.  
**Porcentaje de material:** 60% de fibra de bambú / 40% PVC.

100%



Código: 160.P-37



Código: 160.P-98



Código: 183.1801



Código:183.1802

**Materia:** WPC.  
**Código:** PW01.183  
**Medidas:** 2.9 m\* 16 cm \* 18 mm.  
**Porcentaje de material:** 60% de fibra de bambú / 40% PVC.

100%

**Materia:** WPC.  
**Código:** PW01.203  
**Medidas:** 2.9 m\* 20 cm \* 10 mm.  
**Porcentaje de material:** 60% de fibra de bambú / 40% PVC.

100%



Código:203.2003



Código:203.2004



Código: 203.P-08



Código:203.P-36



Código: 203.2022



5 años de garantía.



Ignífugo.



Anti-polillas

10

Panel wall de exteriores WPC  
Modelo: 220



5 años de garantía.



Ignífugo.



Anti-polillas

Materia: WPC.

Código: PW03

Medidas:

2.9 m\* 22 cm \* 26 mm.

Porcentaje de material:

60% Fibra de bambú / 30% PVC / 10% HDPE.



100%

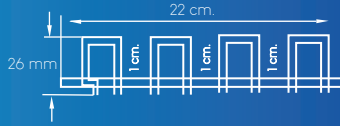

Código: 220.1802

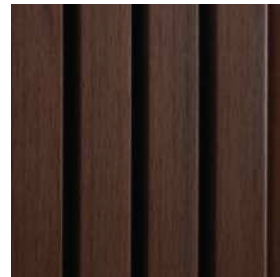

Código:220.1803



Código:220.Coffee



Código:220.Red



Código:220.Teak

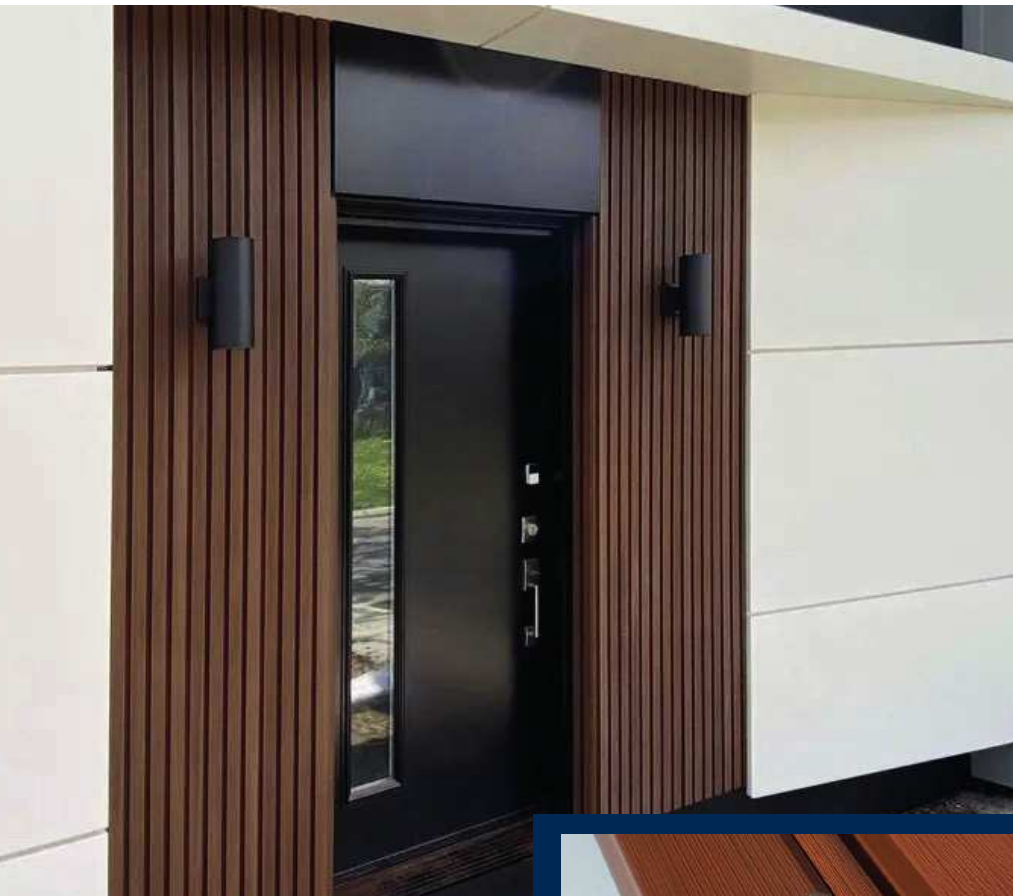

Terminales.

Materia: WPC.

Código: LQ01.50

Medidas:

2.9 m\* 5 cm \* 4 mm.

Porcentaje de material:

60% Fibra de bambú / 30% PVC / 10% HDPE.



100%

El Listón WPC es un producto decorativo que sirve para dividir espacios, listo para instalar en cualquier ambiente (Pared o techo) ideal para el hogar, oficina, recepción, corredor y cualquier tipo de ambiente.

**Materia:** WPC.

**Código:** LT0050

**Medidas:**  
2.9 m\* 10 cm \* 50 mm.

**Porcentaje de material:**  
60% Fibra de bambú / 40 % PVC.

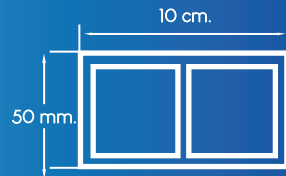

Código:P-37



5 años de garantía.



Ignifugo.



Anti-polillas

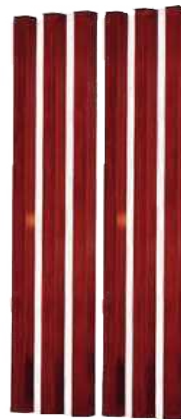

Código:P-55



5 años de garantía.



Ignifugo.



Anti-polillas



Impresión brillante, estampado en caliente, impresión de película de transferencia, laminado.

Material: Spc.  
Código:1220.

Medidas:  
2,44 m\* 1,22 m \* 3 mm.  
Porcentaje de material:  
60 % Piedra caliza / 40% PVC

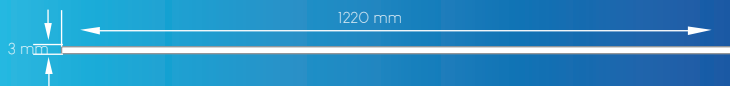

5 años de garantía.



Ignífugo.



Anti-polillas

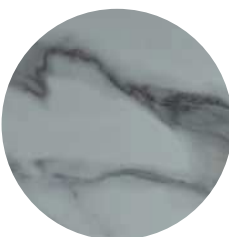

Código: SPC01



Código: SPC02



Código: SPC03

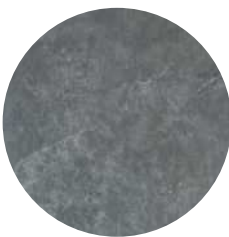

Código: SPC05



Código: SPC06

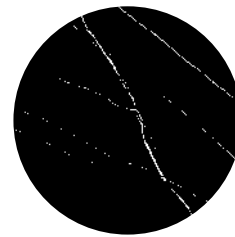

Código: SPC07



Código:SPC80651



Código: SPC8254



Código: SPC48



Código: SPC43



Código: SPC8302



Código: UV01



Código: UV02



Código: SPC1055

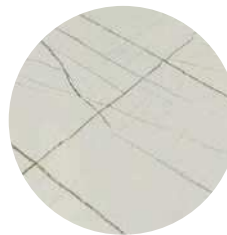

Código: SPC82314



Código: SPC82261

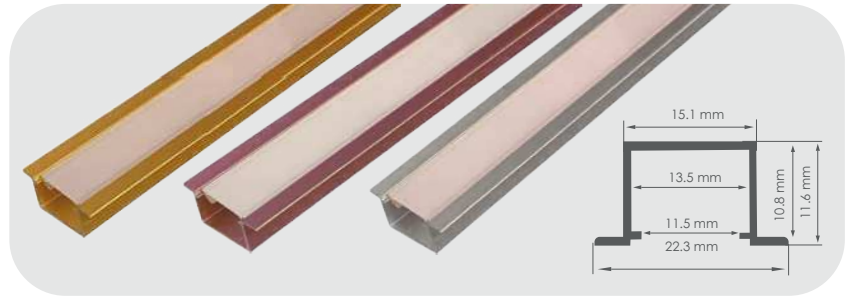

### Canaletas para luz led

- AL07.001- Oro / Oro rosa / Plata.
- Medidas: 2900 \* 22.5 \* 14 mm.



### Canaletas para luz led

- AL06.35.- Oro / Oro rosa / Plata.
- Medidas: 2900 \* 28.6 \* 12.9 mm.

## Acessorios

para Panel wall ecológico

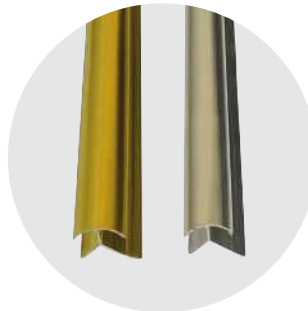

### Perfil de esquina exterior.

- AL02.35 (Oro / Plata).
- Medidas: 2450 \* 12 \* 10 mm.



### Perfil U.

- AL03.35 (Oro / Plata).
- Medidas: 2450 \* 15 \* 4 mm.

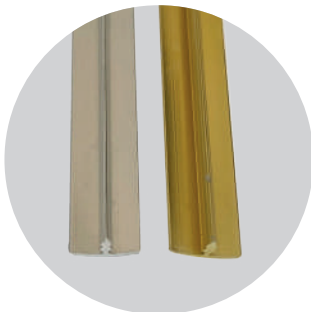

### Perfil simple.

- AL05.35 (Oro / Plata).
- Medidas: 2450 \* 7 \* 3 mm.

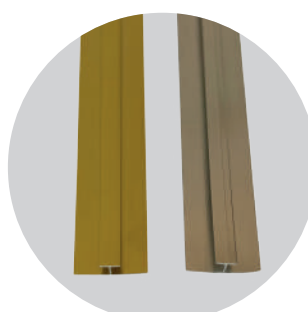

### Perfil H.

- AL01.35 (Oro / Plata).
- Medidas: 2450 \* 22 \* 3 mm.



### Perfil de esquina exterior.

- AL04.35 (Oro / Plata).
- Medidas: 2450 \* 20 \* 10 mm.

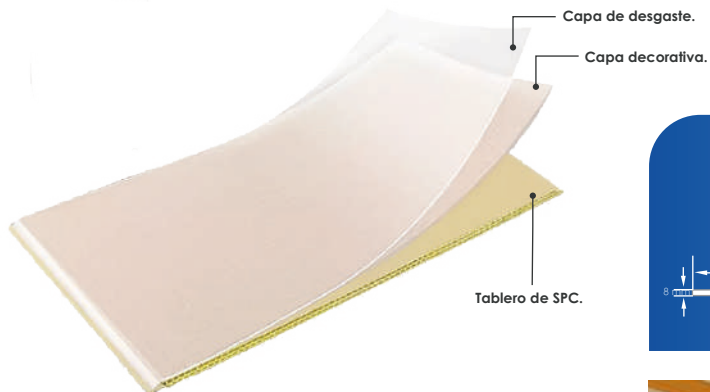

Impresión brillante, estampado en caliente, impresión de película de transferencia, laminado.

**Material:** PVC  
**Código:** PP01.600

**Medidas:**  
2.9 m\* 60 cm \* 8 mm.



Código: 804206



Código: XD9086-1



Código: XD9073-1



Código: XK7005A153



Código: C043P



Panel wall  
ecológico WPC

Uso residencial y comercial.

**Material:** WPC  
**Código:** PW02.600  
**Medidas:**  
3 m\* 60 cm \* 8 mm.

60% de fibra de bambú / 40% PVC



Código: 8017



Código: 8026



Código: 8027



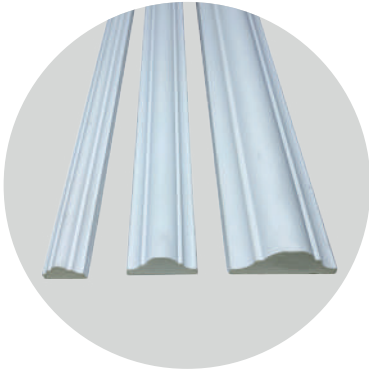

**Línea Romana 25 / 40 / 60**

- Código: LR01.
- Medidas: 2450 mm.

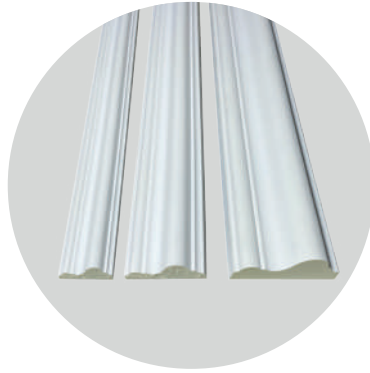

**Línea de puerta 25 / 40 / 60**

- Código: LP01.
- Medidas: 2450 mm.



**Línea de Zócalo 100**

- Código: LZ01.100
- Medidas: 2450 mm.

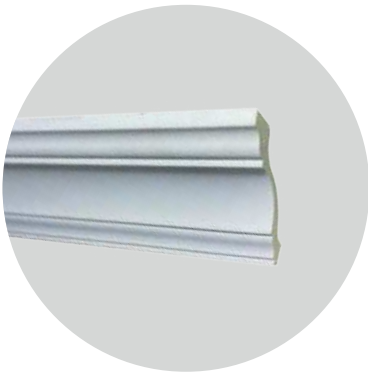
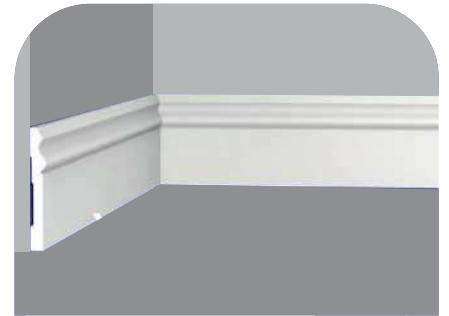
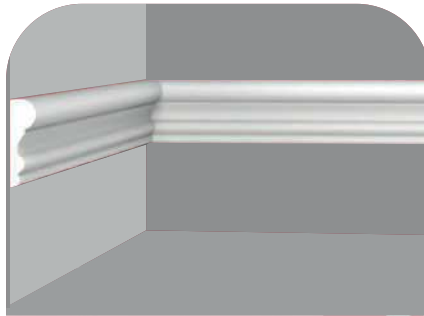
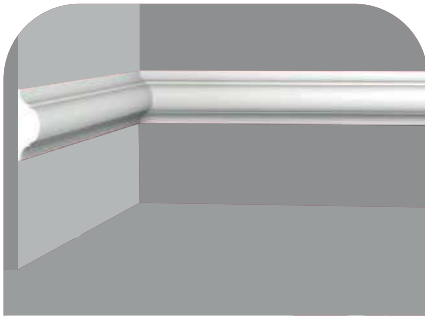

**Línea de Ángulo superior 100**

- Código: LA01.100
- Medidas: 2450 mm.



**Florituras 26**

- Código: AS02.26
- Medidas: 26 \*26 cm.



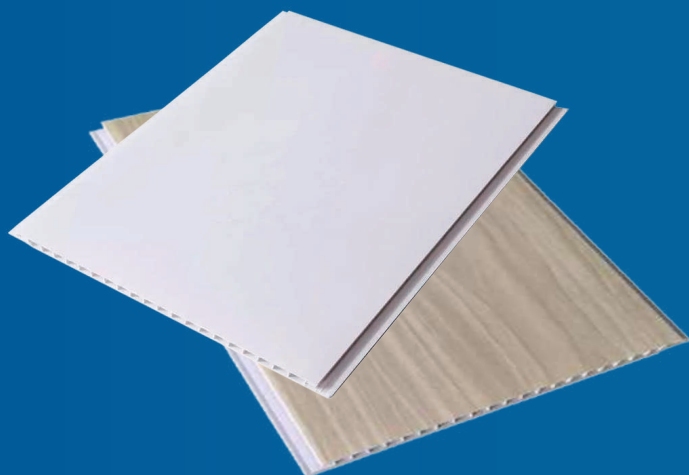

## Cielo raso de PVC.

Tienen una mayor durabilidad debido a su elevada resistencia.

Térmicos, acústicos, no tóxicos, acabado superior, cero mantenimiento, resistente a químicos, machihembrado perfecto.

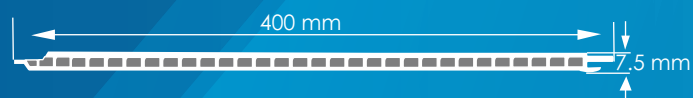

Medidas: 2.9 m \* 40 cm \* 7.5 mm.

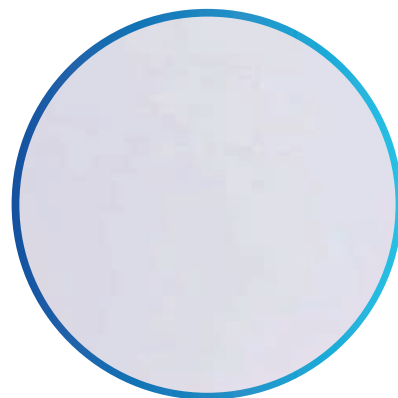

Código: NB689902-2



Código: NB98001-111

## Paneles de policarbonato

Los paneles policarbonato están compuestos por cámara de aire o alveolos que otorgan transparencia, alta resistencia y muy poco peso. Ideal para cubiertas de techo y separadores de ambientes.



Medidas: 2.9 m \* 1.05 m \* 6 mm.

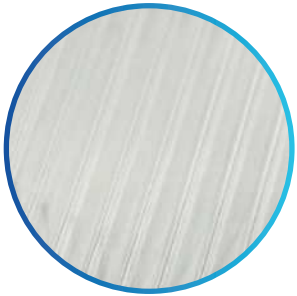

Código: 1050.001  
Color: Transparente.



Código: 1050.002  
Color: Chocolate.

### Accesorios para panel wall

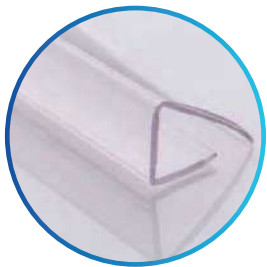

#### Perfil "U"

Código: AS08.06  
Medidas: 6mm \* 2.90 m

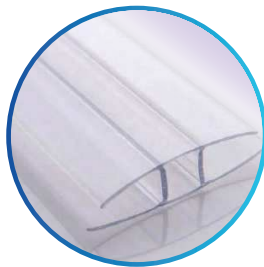

#### Perfil "H"

Código: AS07.06  
Medidas: 6mm \* 2.90 m



# 18 Accesorios para cielo raso

## Grapas Sujetador de panel

Código: AS03.4002

Medidas: 5 \* 3.5 mm

Uso: para techo / wall panel / panel ecológico (PVC- WPC).



## Silicona

Adhesivo para la construcción

Código: AS03.0001

Cantidad: 300 ml.

Uso: para techo / Wall panel / Panel ecológico (PVC- WPC) / Madera / Vidrio.

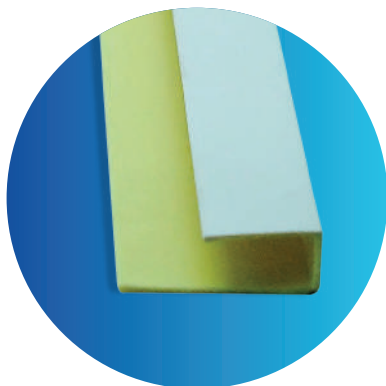

## TERMINADO

- Código: LT01.30.
- Medidas: 2900 \* 40 \* 30 mm

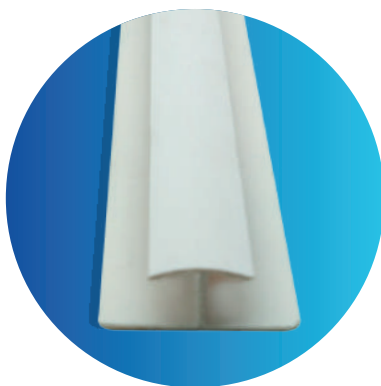

## ACCESORIO H

- Código: AS07.30
- Medidas: 2900 \* 10 \* 30 mm

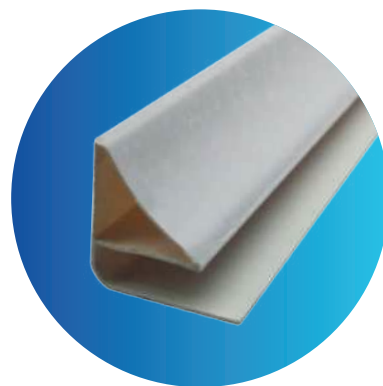

## ACCESORIO DE ESQUINA

- Código: AS08.30
- Medidas: 2900 \* 30 \* 55 mm

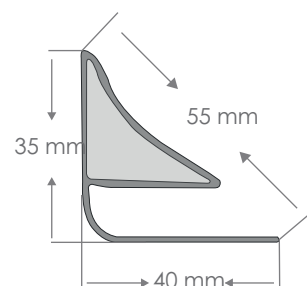
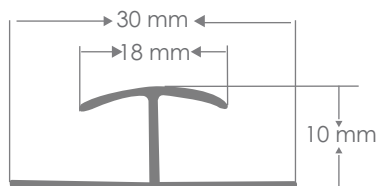
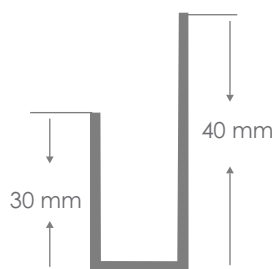

# 19 Accesorios para paneles

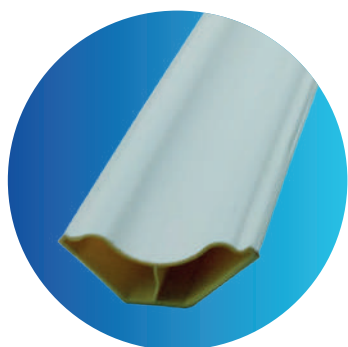

## CÓNCAVA / 50

- Código: LE01.50
- Medidas: 2900 \* 50 \* 30 mm



## ÁNGULO SUPERIOR

- Código: LA01.100
- Medidas: 2900 \* 70 \* 52 mm

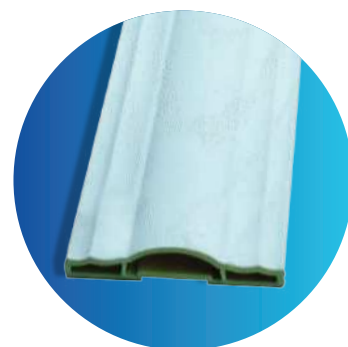

## ROMANA / 50

- Código: LR01.50
- Medidas: 2900 \* 50 \* 30 mm

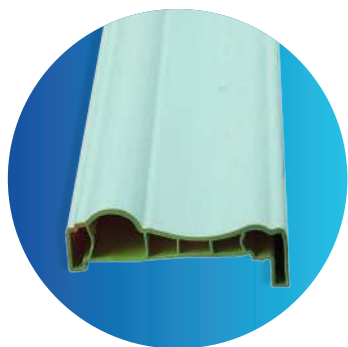
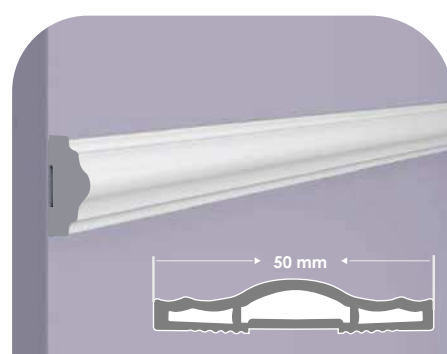

## FALDA DE PARED / 70

- Código: LF01.70
- Medidas: 2900 \* 70 \* 30 mm

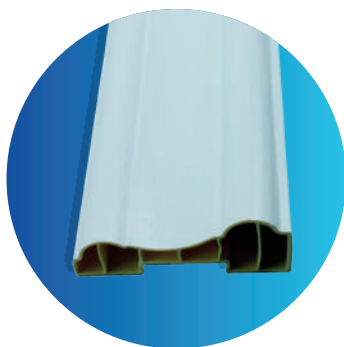
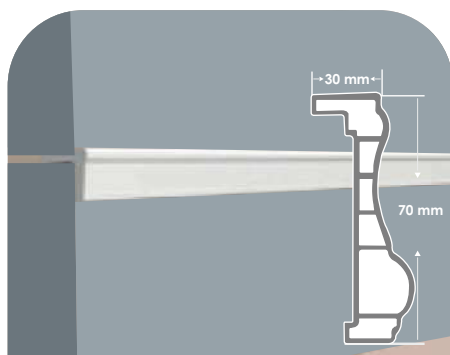

## DECORATIVA / 80

- Código: LP01.80
- Medidas: 2900 \* 80 \* 8 mm

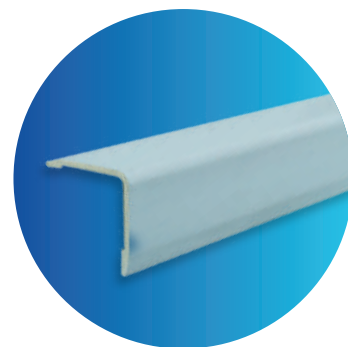
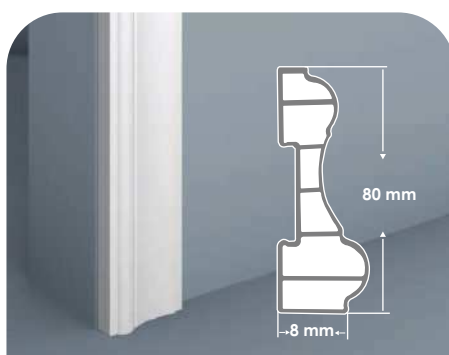

## QUEBRADA / 30

- Código: LQ01.30
- Medidas: 2900 \* 30 \* 30 mm

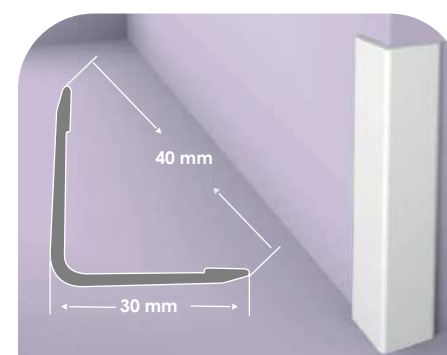



Código: PT05.850-11



Código: PT05.850-05

Medidas: 85 cm x 2.07m.  
 Material: Aleación de zinc.  
 Proposito especial: Aislamiento acústico.  
 Peso: 40 Kg.  
 Nivel de seguridad: Grado A.  
 Incluye: Marco / Puerta / Cerradura.

**Cerradura grande**  
 de color negro.  
**Posición de cerradura:**  
 Izquierda / Derecha.

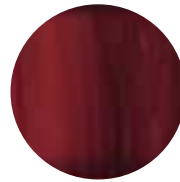

Color: Caoba



Color: Gris

Medidas: 70 cm x 2.07m.  
 Material: Vidrio - Aluminio.  
 proposito especial: especial antióxido.  
 Peso: 20 Kg.  
 Nivel de seguridad: Grado A.  
 Incluye: Marco / Puerta / Manija.

**Vidrio templado:**  
 doble cara de 0,8 mm.  
**Uso:**  
 para baños.

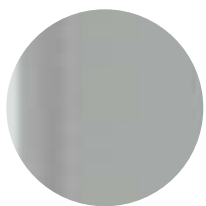

Color: Blanco.

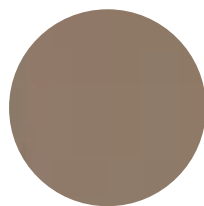

Color: Champan.





# VIDAR

INNOVACIÓN ECOLÓGICA

 (01) 245 3441 / 534 0913

 992 329 933 / 937 002 902 / 923 355 742

 AV. Colonial 256, Cercado de Lima.  
AV. Alfredo Mendiola # 445 S.M.P. - Lima.